

# PicoDrive P 50 ED

## INSTRUCTION MANUAL

Part 3

Parameter list

This Instruction Manual is valid for drives  
from the following software version on:

P 50 ED # 1\_050\_13 →

The reprinting, copying or translation of PFAFF Instruction Manuals, whether in whole or in part, is only permitted with our previous authorization and with written reference to the source.

**PFAFF Industriesysteme  
und Maschinen AG**

Hans-Geiger-Str. 12 - IG Nord  
D-67661 Kaiserslautern

## List of Contents Part 3

<b>Chapt. Contents</b>	<b>Page</b>
<b>11.</b> Survey and List of Parameters	11.1 - 11.9
11.1 Explanation of Parameter Survey	
11.2 Explanation of Parameter List	
11.3 Parameter Survey	
11.4 List of Parameters	
<b>12.</b> Electrical Connections Diagram	12.1 - 12.4
Appendix adaptor cable	12.5

**Technical updatings reserved!**

## 11. Survey and List of Parameters

### 11.1 Explanation of Parameter Survey

The parameter survey is designed as an aid for finding parameters quickly. It is a summary of references for the parameter list. Listed behind each reference are all parameters which exert an influence on the function described by the reference.

The parameter survey is divided into five columns:

Column 1 shows the references (functions) to which parameters are assigned.

Column 2 shows the abbreviations of the respective functions.

Column 3 shows all parameters (setting numbers) belonging to the respective reference.

Column 4 shows, for each function (reference) which controls inputs or outputs, the applicable indications such as Ex or Ax which can also be found on the connections diagram.

Column 5 shows, for each function (control inputs (Ex) or control outputs (Ax)), the respective plugs with the number of contacts (see connections diagram).

Example for searching a parameter:

Keyword (function): inverse rotation

The parameter survey shows in column 3 the parameter numbers 618, 801.

Suppose that the inverse rotation function is to be enabled. The parameter list shows this function under parameter number 618.

### 11.2 Explanation of Parameter List

The parameter list is divided into 5 columns. These comprise, in

column 1: the parameter number,

column 2: is the explanation (meaning) of the parameters and the coding system of row 1 of the keys of the mini operator's panel, used when the parameter concerned can be programmed with the mini operator's panel,

column 3: the programming level (A, B, C) on which the parameter in question can be accessed,

column 4: the range of values within which the parameter in question can be set,

column 5: the value of the parameter in question is set on delivery ex factory.

Parameters having "either/or" validity (software switches) can merely be set to value I or II. In the case of such parameters, column 4 is empty.

Parameter numbers in acute brackets; e.g. <105>, mean the value (content) set for the parameter in question.

Example:

**107** Speed for front backtack when <106> = I

I limited by <105>

II limited by <607>

Explanation:

Parameter 107 is valid only the the value (content) of parameter <106> = I.

If parameter 107 is set to I (<107> = I), then the speed for the front backtack is limited by parameter 105, e.g. <105> = 1500. If parameter 107 is set to II (<107> = II), then the speed for the front backtack is limited by the value of parameter 607, e.g. <607> = 4000.

## 11.3 Parameter survey P50ED 1\_050\_13 (PARAM.ENO)

### Reference!

All parameters signed with „\*“ are retained unchanged after a „Master Reset 1“ or „Master Reset 2“ has been performed!

**Attention!** After a „Master Reset 3“ all parameters are set back to there default values!

With the **control box P50ED**, following machine classes are available:

Maschine class 1 = Pfaff 1180 SRP (Speed Regulated Presserfoot system)

Maschine class 2 = Pfaff 1180 Puller

Function	Abbrev'n	Parameter	Input Output	Connection Socket/Contacts
Accelerate	DRZAN	722		
Backtack	RIE	105/107/110 364/523/584 585		
Backtack inversion	RIV	748		
Backtack suppression	RIUNT	748		
Blower	BLA	668		
Brake	DRZAB	723		
Catcher	FANG	707		
Chopper	MESSE	105/110		
Control	REG	880/884/885 886/887/889 890/900		
Decorative backtack	ZRIE	522/523/530 775		
Defect search	HWT	797		
Delay	VERZ	623/642/643 730/761/770 939		
Direction of rotation	DRR	800		
Display	ANZ	605/933		
Edge trimmer	KS	356/387/776		
End backtack	ER	110/254		
Engine	MOT	897		

Feed reverse	TUM	301/364/494 643/721/939
Front backtack	AR	105/106/107 252
Hardware test	HWT	797
Inverse rotation	RDR	618/623/801
Linear motor	LINMOT	251/252/253 254/256/258 259/261/262 268/269/287 288/289/302 383/384/385 668
Machine class	MAKL	799
Machine run	ML	387
Needle position	NAPO	522/700/702 703/705/706 707/710/746 748
Needle position change-over	NPW	446/748
Needle up without trimming	NHOS	446/710/748
Number of stitches	STZA	111/112/445 499/760
ON period	EINZ	528/715/889
Operator panel	BDF	101
Photocell	LS	111/112/113 163/199/615
Presser foot	PF	251/256/258 268/269/287 288/318/356 383/384/385 642/651/668 719/729/730 770
Program	PR	203/206/311 313
Programming level C	EBC	798
Puller	PULL	252/253/254 256/259/261 262/264/265 289/302/318 445/499
Residual brake	STBR	718
Seam end	NE	110/206/254

Seam start	NA	105
Single stitch	EST	446/748
Soft start	SANL	116/117
Speed	DRZ	105/106/107 110/117/199 203/530/585 605/606/607 608/609/901
Speed decrease	DRZAB	723
Speed increase	DRZAN	722
Speed limitation	DB	585
Stacker	STAP	528/776
Start	START	113
Start delay	STVERZ	729
Stitch condensation	STVD	105/106/107 110/364
Stitchcounter	STZ	760
Stop	STOP	206
Stop time	STOPZ	775
Target stitch	PEIPO	653/789
Thread clamp	FK	494
Thread monitor	FW	382/660/760
Thread puller	FZ	761
Thread tension release	FSL	538/707/761
Thread trimming	SN	311/609/705 706/734/901
Thread wiper	WI	668/715
Time needed to switch on	EINZ	528/715/889
Timing output	TA	538/642/643 705/719/721 734
Vacuum	SAUG	105/110/356
Zigzag machine	ZZ	746

## 11.4 List of Parameters P50ED 1\_050\_13 (PARAM.EN)

No.	Function (Meaning)	Level	Range Values	of Value	Standard Value
101	(BDF) Audible signal of the control panel pushbutton 1 = on 0 = off	A,B,C		0	Kl. 1, 2
105	(AR/RIE/DRZ/MESSER/NA/SAUG/STVD) Speed for front backtack / stitch condensation	B,C	0300 - 2000	1200	Kl. 1, 2
106	(AR/DRZ/STVD) Speed for front backtack / stitch condensation 1 variable (treadle-controlled) 0 constant (corresponding to <105>)	B,C		0	Kl. 1, 2
107	(AR/RIE/DRZ/STVD) Speed for front backtack / stitch condensation when <106> = I 1 limited by <105> 0 limited by <607>	B,C		0	Kl. 1, 2
110	(ER/RIE/DRZ/MESSER/NE/SAUG/STVD) Speed for end backtack / stitch condensation	B,C	0300 - 2000	1200	Kl. 1, 2
111	(LS/STZA) Light barrier compensation stitches 1 (stitches from light barrier clear to seam end)	A,B,C	0001 - 0030	8	Kl. 1, 2
112	(LS/STZA) Number of stitches for light barrier fade-out on knit fabrics (according to stitch size)	A,B,C	0000 - 0100	0	Kl. 1, 2
113	(LS/START) Start with light barrier 1 when light barrier is dark only 0 also when light barrier is clear	B,C		0	Kl. 1, 2
116	(SANL) Soft start stitches	A,B,C	0000 - 0030	0	Kl. 1, 2
117	(SANL/DRZ) Speed for soft start stitches	B,C	0030 - 0640	400	Kl. 1, 2
163	(LS) Sewing with photocell 1 yes 0 no	B,C		0	Kl. 1, 2
199	(DRZ/LS) Speed for light barrier compensation stitches	B,C	0300 - 2000	1200	Kl. 1, 2
203	(PR/DRZ) Speed for seam program 1 variable (treadle-controlled) 0 constant (corresponding to <221> or <222>)	B,C		1	Kl. 1, 2
206	(NE/PR/STOP) Interrupt/discontinue seam sections at speed = constant (<203> = II) 1 with treadle -2 0 with treadle 0	B,C		0	Kl. 1, 2
251	(LINMOT/PF) Raise level of the presser foot	B,C	0000 - 0250	190	Kl. 1 - Kl. 2
252	(AR/LINMOT/PULL) Raise level of the puller (linear motor) with AR	B,C	0000 - 0250	140	Kl. 1 0005 - 0100 30 Kl. 2
253	(LINMOT/PULL) Angle for start of puller during intermittent operation	B,C	0000 - 0255	20	Kl. 2 * - Kl. 1
254	(ER/LINMOT/NE//PULL) Raise level of the puller (linear motor) with ER and after seam end	B,C	0010 - 0070	40	Kl. 2 - Kl. 1
256	(LINMOT/PF/PULL) Linear motor for puller / presser foot: Factor for basic pressure	B,C	0000 - 0032	10	Kl. 1 - Kl. 2
258	(LINMOT/PF) Type of transportation of the machine 1 needle transportation 0 transportation from underneath	B,C	0000 - 0001	0	Kl. 1 - Kl. 2
261	(LINMOT/PULL) Correction factor for the puller roller feed	B,C	0020 - 0080	55	Kl. 2 * - Kl. 1
262	(LINMOT/PULL) Transportation length (angle) of the puller roller	B,C	0020 - 0140	60	Kl. 2 - Kl. 1
264	(PULL) Current for puller drive after switch on	B,C	0090 - 0150	120	Kl. 2 - Kl. 1



265	(PULL) Run time of the puller roller after switch on	B,C	0001 - 0010	3	Kl. 2
				-	Kl. 1
268	(LINMOT/PF) Angle for presser foot strain relief during needle transportation	B,C	0000 - 0255	24	Kl. 1
				-	Kl. 2
269	(LINMOT/PF) Angle for presser foot strain relief during transportation from underneath	B,C	0000 - 0255	162	Kl. 1
				-	Kl. 2
287	(LINMOT/PF) Raise level of the presser foot with pedal „-1“	B,C	0000 - 0250	140	Kl. 1
				-	Kl. 2
288	(PF/LINMOT) Presser foot pressure with pedal in the zero position	B,C	0000 - 0150	80	Kl. 1
				-	Kl. 2
301	(TUM) Switch-on voltage of the magnet for transport change-over	C		0	Kl. 1, 2
	1 24V				
	0 32V				
302	(LINMOT/PULL) Positional holding current of the linear motor	B,C	0050 - 0150	100	Kl. 2
				-	Kl. 1
311	(PR/SN) Cancellation of stitch count	B,C		1	Kl. 1, 2
	1 with thread cutting				
	0 without thread cutting				
313	(PR) Programs are backtack programs (darning programs)	A,B,C		0	Kl. 1, 2
	1 yes				
	0 no				
318	(PULL/PF) Puller lifts with PFA and activates delayed according to parameter <445>	B,C	0000 - 0099	0	Kl. 2
	1 on			-	Kl. 1
	0 off				
356	(PF/SAUG/KS) Input is at	B,C		1	Kl. 1, 2
	1 Presser foot				
	0 Vacuuming				
364	(RIE/STVD/TUM) Transport change-over means for	B,C		1	Kl. 1, 2
	1 Back-tack				
	0 Stitch condensation				
382	(FW) Switching threshold of the analogue input for the thread monitor	B,C	0000 - 0100	15	Kl. 1, 2
383	(LINMOT/PF) Switch-on angle for presser foot strain relief at the seam start (in the first stitch)	B,C	0000 - 0255	110	Kl. 1
				-	Kl. 2
384	(LINMOT/PF) Switch-off angle for presser foot strain relief	B,C	0000 - 0255	170	Kl. 1
				-	Kl. 2
385	(LINMOT/PF) Presser foot strain relief (lift of stroke) at the seam start if <383> is active	B,C	0000 - 0250	100	Kl. 1
				-	Kl. 2
387	(ML/KS) Output (motor run) is active	B,C		1	Kl. 1, 2
	1 With Pedal = 1D (Motor running)				
	0 With Pedal = 1 (Lower presser foot)				
445	(PULL/STZA) Stitches for puller delay	B,C	0000 - 0099	0	Kl. 2
				-	Kl. 1
446	(NHOS/NPW/EST) Input is	B,C	0001 - 0007	1	Kl. 1, 2
	1 = needle up without trimming				
	2 = needle position change-over				
	3 = single stitch				
	4 = single stitch with reduced length				
	5 = backtack inversion				
	6 = backtack suppression				
	7 = change-over position				
	8 = puller lift switched off				
	9 = change-over needle position step by step, forward				
	10 = change-over needle position step by step, backward				
494	(FK/TUM) Function from external key (E1)	B,C		0	Kl. 1, 2
	0 = manual feed reverse				
	1 = thread clamp at seam start on / off				

499	(STZA/PULL) Number of stitches for slowed down lowering of puller after operating switch S8 (knee switch)	A,B,C	0000 - 0099	0	Kl. 2 Kl. 1
522	(NAPO/ZRIE) Needle position when stop occurs during decorative backtack (stitch in stitch) 1 position 2 (up) 0 position 1 (down)	B,C		0	Kl. 1, 2
523	(RIE/ZRIE) Backtack 1 decorative backtack (stitch in stitch) 0 standard backtack	A,B,C		0	Kl. 1, 2
528	(EINZ/STAP) Duration (ms) of stacker function	B,C	0000 - 2500	120	Kl. 1, 2
530	(DRZ/ZRIE) Speed (max.) for decorative backtack	B,C	0300 - 2000	1000	Kl. 1, 2
538	(FSL/TA) Timing of output (thread tension release) (0 = 100%)	B,C	0010 - 0050	30	Kl. 1, 2
584	(RIE) Backtack 1 four times 0 double	B,C		0	Kl. 1, 2
585	(DRZ/DB/RIE) Speed limitation	B,C	0300 - 2500	1000	Kl. 1, 2
605	(DRZ/ANZ) Actual speed in display (<725>) 1 yes 0 no	B,C		1	Kl. 1, 2
606	(DRZ) Speed: level 1 (min.)	B,C	0030 - 0650	180	Kl. 1, 2
607	(DRZ) Speed: level 12 (max.)	B,C	0300 - 5500	4000	Kl. 1, 2
608	(DRZ) Acceleration curve (Pedal characteristic) 1 = linear 0 = non linear	B,C		1	Kl. 1, 2
609	(SN/DRZ) Trimming speed 1	B,C	0060 - 0300	180	Kl. 1, 2
615	(LS) End recognition when photocell goes 1 from light to dark 0 from dark to light	B,C		0	Kl. 1, 2
618	(RDR) Inverse rotation after seam end 1 yes 0 no	B,C		0	Kl. 1, 2
623	(RDR/VERZ) Delay in start-up time (ms) for inverse rotation	B,C	0000 - 2000	30	Kl. 1, 2
642	(PF/VERZ/TA) presser foot time from switch-on to voltage reduction (cycling)	B,C	0010 - 0100	100	Kl. 1 Kl. 2
643	(TUM/VERZ/TA) feed reverse time from switch-on to voltage reduction (cycling)	B,C	0010 - 0100	100	Kl. 1, 2
651	(PF) Presser foot with automatic descent on machine stop 1 yes 0 no	B,C		1	Kl. 1, 2
653	(PEIPO) Target stitch before sewing 1 yes 0 no	B,C		0	Kl. 1, 2
660	(FW) Bobbin thread monitoring 0 without (= *II*) 1 via a sensor (= **I*) 2 by a stitch count	A,B,C	0000 - 0002	0	Kl. 1, 2
668	(BLA/LINMOT/PF/WI) Thread wiper/thread clearer 1 yes 0 no	B,C		0	Kl. 1, 2
700	(NAPO) Needle position 0 (reference position of the needle)	B,C	0000 - 0255	0	Kl. 1, 2 *
702	(NAPO) Needle position 1 (needle down)	B,C	0000 - 0255	90	Kl. 1, 2
703	(NAPO) Needle position 2 (thread take-up lever up)	B,C	0000 - 0255	226	Kl. 1, 2
705	(NAPO/SN/TA) Needle position 5 (end of trimming signal 1 (magnetic thread trimmer) / clock pulses start of the trimming signal 1)	B,C	0000 - 0255	200	Kl. 1, 2

706	(NAPO/SN) Needle position 6 (start trimming signal 2 (pneumatic thread trimmer))	B,C	0000 - 0255	136	Kl. 1, 2
707	(NAPO/FSL/FANG) Needle position 9 (thread tension release or thread catcher start)	B,C	0000 - 0255	164	Kl. 1, 2
710	(NAPO/NHOS) Needle position 3 (needle up)	B,C	0000 - 0255	184	Kl. 1, 2
715	(EINZ/WI) Duration (ms) of thread wiper	B,C	0000 - 2000	60	Kl. 1, 2
718	(STBR) Timing of residual brake (0 = brake off)	B,C	0000 - 0100	0	Kl. 1, 2
719	(PF/TA) Timing output (lifting presser foot) (0 = 100% switched on)	B,C	0010 - 0060	40	Kl. 1, 2
721	(TUM/TA) Timing output (feed reverse) (0 = 100% switched on)	B,C	0010 - 0060	40	Kl. 1, 2
722	(DRZAN) Acceleration ramp 1 gradual 50 steep	B,C	0001 - 0060	50	Kl. 1, 2
723	(DRZAB) Brake ramp 1 gradual 50 steep	B,C	0001 - 0060	40	Kl. 1, 2
729	(STVERZ/PF) Start delay after lowering presser foot	B,C	0010 - 2000	120	Kl. 1, 2
730	(PF/VERZ) Lift delay for presser foot after seam end	B,C	0000 - 2000	50	Kl. 1, 2
734	(SN/TA) Timing output (thread trimmer) (0=100% switched on)	B,C	0010 - 0040	10	Kl. 1, 2
746	(NAPO/ZZ) Needle position for change-over, zick-zack or three-fold-stitch	B,C	0000 - 0255	90	Kl. 1, 2
748	(NHOS/NPW/EST/RIV/RIUNT/NAPO) Input is 1 = needle up without trimming 2 = needle position change-over 3 = single stitch 4 = single stitch with reduced length 5 = backtack inversion 6 = backtack suppression 7 = change-over position 8 = puller lift switched off 9 = change-over needle position step by step, forward 10 = change-over needle position step by step, backward	B,C	0001 - 0007	5	Kl. 1, 2
760	(FW/SPFW/STZ/STZA) - Stitch count for the remnant thread after the bobbin thread monitor responds with direct bobbin thread monitoring - Multiplier for the fixed value (200) for determining the start value of the stitch counter with indirect bobbin thread monitoring	A,B,C	0000 - 0250	5	Kl. 1, 2
761	(FSL/FZ/VERZ) Prolongation thread tension release / thread puller	B,C	0000 - 0080	0	Kl. 1, 2
770	(PF/VERZ) Lifting delay of presser foot at threadle- position „-1“	B,C	0010 - 0250	80	Kl. 1, 2
775	(ZRIE/STOPZ) Stop time (ms) with stitch in stitch backtack (decorative backtack)	B,C	0010 - 1000	100	Kl. 1, 2
789	(PEIPO) Needle position 10 (target stitch)	B,C	0000 - 0255	248	Kl. 1, 2
797	(HWT) Hardware test 1 yes 0 no	C		0	Kl. 1, 2
798	(EBC) Programming level C 1 yes 0 no	A,B,C	0000 - 0020	1	Kl. 1, 2
799	(MAKL) Machine class which has been selected	C	0001 - 0002	1 2	Kl. 1 * Kl. 2

800	(DRR) Direction of motor rotation viewed from belt pulley 1 left-hand rotation 0 right-hand rotation	C	0000 - 0001 0	Kl. 1, 2 *
801	(RDR) Reverse rotation angle after seam end	B,C	0010 - 0212 32	Kl. 1, 2
880	(REG) Starting current max. [A]	C	0001 - 0010 5	Kl. 1, 2
884	(REG) Proportional amplification of the speed control (in general)	B,C	0003 - 0024 10	Kl. 1, 2
885	(REG) Integral amplification of the speed control	C	0010 - 0080 50	Kl. 1, 2
886	(REG) Proportional amplification of the order controllers	C	0001 - 0015 8	Kl. 1, 2
887	(REG) Differential amplification of the order controllers	C	0001 - 0015 8	Kl. 1, 2
889	(EINZ/REG) Time required for order controlling (0 = always)	C	0000 - 2500 200	Kl. 1, 2
890	(REG) Proportional amplification of the superior order controllers for the residual brake	C	0001 - 0025 15	Kl. 1, 2
897	(MOT) MINI motor version 1 long 0 short	C	0000 - 0001 0	Kl. 1, 2 *
900	(REG) Additional P-Amplification of the speed control	B,C	0001 - 0024 14	Kl. 1, 2
901	(DRZ/SN) Trimming release speed	B,C	0030 - 0500 300	Kl. 1, 2
933	(ANZ) Display change-over 1 diagnosis 0 normal display	C	0	Kl. 1, 2
939	(VERZ/TUM) Rate time (premature change-over) for the transport changer when switching on	B,C	0010 - 0200 30	Kl. 1, 2
969	(VERZ/TUM) Switching off angel for presserfoot during threadwiping at seam start	B,C	0000 - 0255 100	Kl. 1, 2
985	(FK) Switch on angle for thread clamp	B,C	0000 - 0255 67	Kl. 1, 2
986	(FK) Switch off angle for thread clamp	B,C	0000 - 0255 206	Kl. 1, 2
989	(FK/FZ/NA) Thread clamp at seam start 0 = A3 is thread wiper 1 = A3 is thread puller 2 = Presserfoot is lifting with thread puller	B,C	0000 - 0002 0	Kl. 1, 2

# 12. Electrical Connections Diagram X5 P50ED

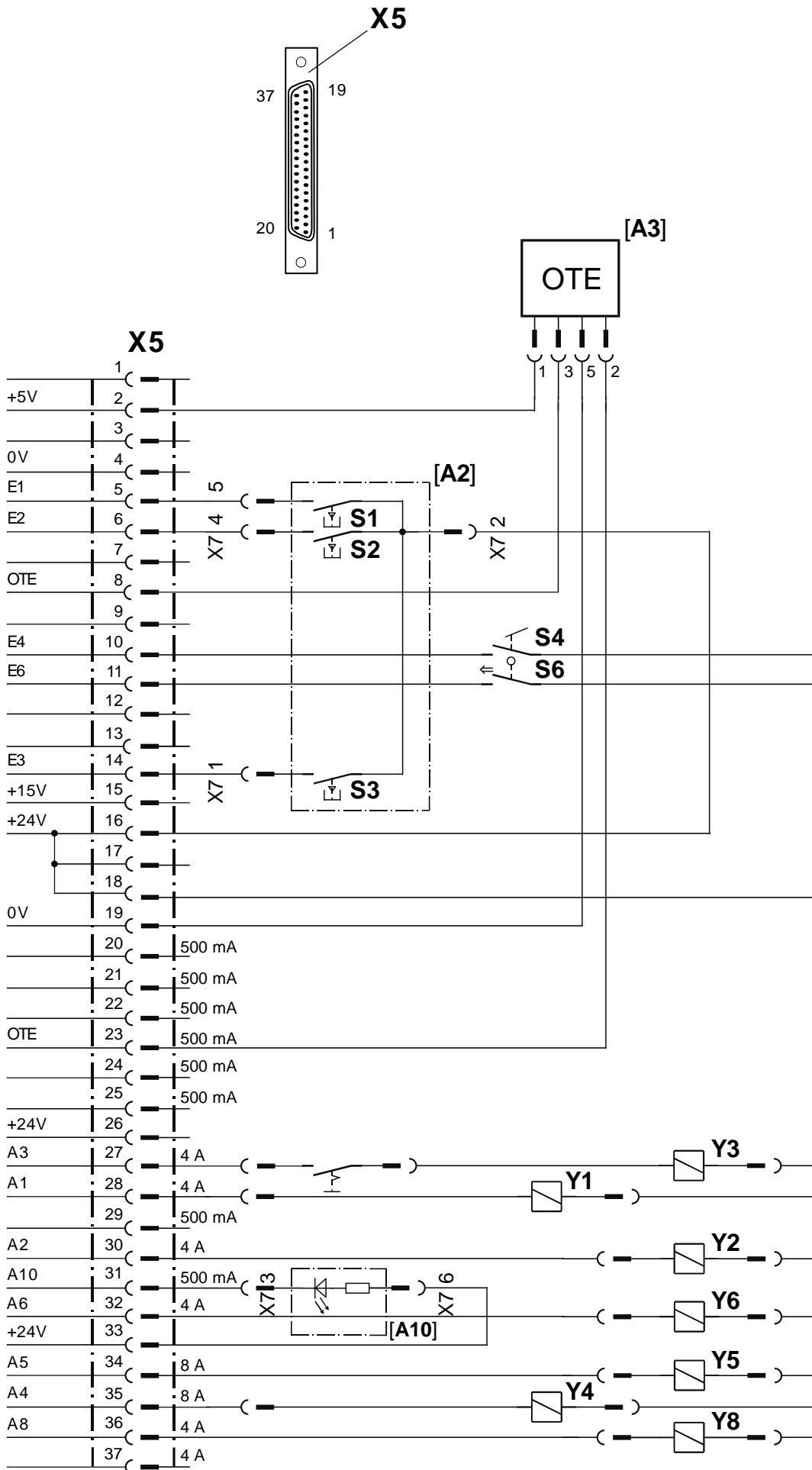

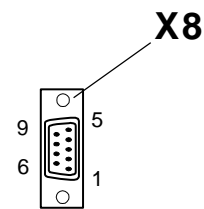
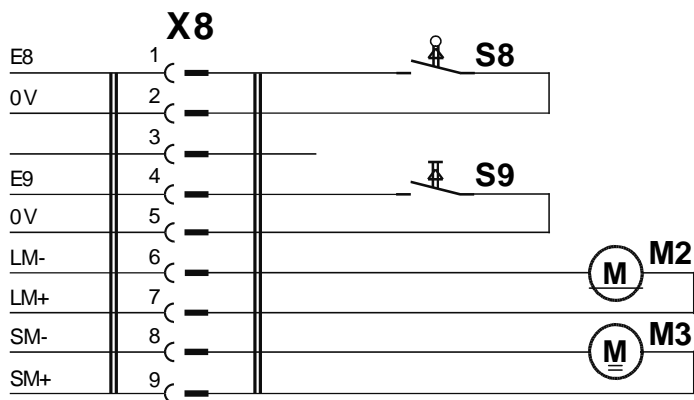



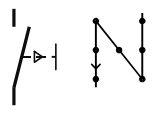
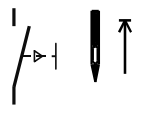
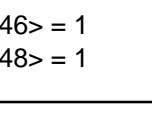
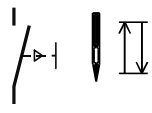
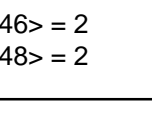
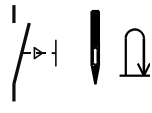
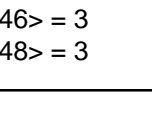
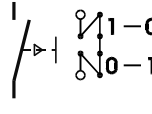
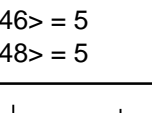
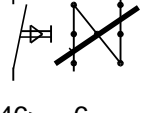
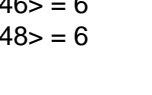



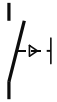

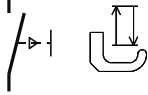
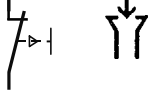
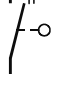

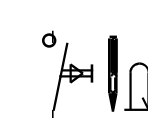



Bedeutung der Magnete bzw. Magnetventile, Taster / Meaning of magnets and/or solenoids and keys  
 Signification des aimants resp. solenoides et touches / Significação dos imaões e/ou as solenoidas e teclas  
 Significato dei magneti, delle valvole magnetiche e dei tasti / Significación de los imanes y/o los solenoides  
 y pulsadores / Betekenis van de magneten resp. magneetkleppen, toetsen

<b>S1</b> 	Transportumstellung von Hand / manual feed reverse / renversement de marche manuel / mudança do transporte manual / commutazione trasporto a mano / inversión de transporte manual / handmatige transportomschakeling
<b>S2</b>  <b>S3</b>  S2 <446> = 1 S3 <748> = 1	Nadel hoch ohne Schneiden / needle up without thread trimming / aiguille en haut sans coupe / agulha para cima sem corte de linhas / ago su senza taglio / aguja arriba sin corte / naald omhoog zonder snijden
<b>S2</b>  <b>S3</b>  S2 <446> = 2 S3 <748> = 2	Nadelpositionswechsel / needle position change-over / changement de position d'aiguille / troca de posição da agulha / cambio di posizione dell'ago / cambio de posición de aguja / naaldpositie-verwisseling
<b>S2</b>  <b>S3</b>  S2 <446> = 3 S3 <748> = 3	Einzelstich / single stitch / point unique / ponto individual / punto singolo / puntada individual / enkele steek
<b>S2</b>  <b>S3</b>  S2 <446> = 5 S3 <748> = 5	Nachfolgende Riegelfunktion invertieren / invert subsequent backtack function / inverser la prochaine fonction de bridage / inverter o próximo remate / invertire la funzione d'affr. successiva / invertir la próxima función de remate / inverteren op elkaar volgende hechtfunctie
<b>S2</b>  <b>S3</b>  S2 <446> = 6 S3 <748> = 6	Riegelunterdrückung / backtack suppression / suppression de bridage / supressão do remate / soppressione dell'afrancatura / supresion del remate / onderdrukking van het strookje

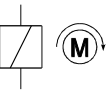
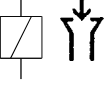
Bedeutung der Magnete bzw. Magnetventile, Taster / Meaning of magnets and/or solenoids and keys  
 Signification des aimants resp. solenoides et touches / Significação dos imãs e/ou as solenoidas e teclas  
 Significato dei magneti, delle valvole magnetiche e dei tasti / Significación de los imanes y/o los solenoides  
 y pulsadores / Betekenis van de magneten resp. magneetkleppen, toetsen

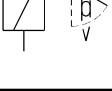
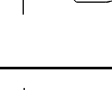
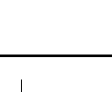
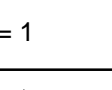
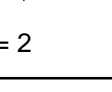
<p><b>S2</b> </p> <p><b>S3</b> </p> <p>S2 &lt;446&gt; = 7 S3 &lt;748&gt; = 7</p>	<p>Umschaltposition / Change-over position / position le commutation / posição de mudança / posizione di commutazione / posición de cambio / omshakeling position</p>
<p><b>S4</b> </p> <p>&lt;356&gt; = I</p>	<p>Presserfuß / presser foot / pied presseur / calcador / alzapiedino / prensatelas / drukvoet</p>
<p><b>S4</b> </p> <p>&lt;356&gt; = II</p>	<p>Saugen / vacuuming / aspiration / aspirar / aspirare / aspirar / zuigen</p>
<p><b>S6</b> </p>	<p>STOP/Anlaufsperr / STOP/Safety switch no run / STOP/Verrouillage de remise en marche / STOP/Bloqueio de arranque / STOP/Blocco avviamento / STOP/Bloqueo de repuesta en marcha / STOP/Startblokkering</p>
<p><b>S8</b> </p> <p>&lt;799&gt; = 2</p>	<p>Rückmeldung: Puller oben / feed back: puller up</p>
<p><b>S8</b> </p> <p>&lt;799&gt; = 1</p>	<p>Knieschalter für Presserfuß heben / knee switch for presser foot up</p>
<p><b>S9</b> </p> <p>&lt;799&gt; = 2</p>	<p>Knieschalter für Puller heben / knee switch for puller up</p>
<p><b>M2</b> </p> <p>&lt;799&gt; = 1</p>	<p>Presserfußdruck / presser foot pressure</p>
<p><b>M2</b> </p> <p>&lt;799&gt; = 2</p>	<p>Pullerdruck / puller pressure</p>
<p><b>M3</b> </p>	<p>Puller Antrieb / puller motor puller moteur / puller motor / puller motore / estirar motor / puller motor</p>

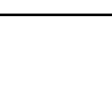
Bedeutung der Magnete bzw. Magnetventile, Taster / Meaning of magnets and/or solenoids and keys  
 Signification des aimants resp. solenoides et touches / Significação dos imãs e/ou as solenoidas e teclas  
 Significato dei magneti, delle valvole magnetiche e dei tasti / Significación de los imanes y/o los solenoides  
 y pulsadores / Betekenis van de magneten resp. magneetkleppen, toetsen

<p><b>Y1</b>                    I max                  4 A *                  &lt;356&gt; = I</p>	<p>Motorlauf / motor runs / moteur en marche /                  motor em movimento / motore in moto / motor en marcha /                  loop van de machine</p>
<p><b>Y1</b>                    I max                  4 A *                  &lt;356&gt; = II</p>	<p>Absaugung / vacuum /                  aspiration / aspirar /                  aspirazione / aspiración / zuigen</p>
<p><b>Y2</b>                    I max                  4 A *                  &lt;356&gt; = I</p>	<p>Fadenschneiden / thread trimmer /                  coupe-fil / corte de linhas /                  rasafilo / cortahilos /                  draadsnijder</p>
<p><b>Y3</b>                    I max                  4 A *                  &lt;356&gt; = I</p>	<p>Fadenwischer / thread wiper / écarteur de fil /                  retira-linhas / scartafilo / retirahilos /                  draadwisser</p>
<p><b>Y4</b>                    I max                  8 A *                  &lt;356&gt; = I</p>	<p>Presserfuß heben / lifting presser foot / relevage du pied presseur /                  levantar do calcador / sollevamento del alzapiedino /                  elevación de prensatelas /                  drukvoet optillen</p>
<p><b>Y5</b>                    I max                  8 A *                  &lt;356&gt; = I</p>	<p>Transportumsteller / feed reverse /                  renversement de marche / mudança do transporte / commutazione trasporto /                  inversión de transporte / transportomschakeling</p>
<p><b>Y6</b>                    I max                  4 A *                  &lt;776&gt; = 1</p>	<p>Kantenschneider / edge trimmer                  coupe de bord / corte cantos                  rasa bordi / corta bordes                  zoomsnijder</p>
<p><b>Y6</b>                    I max                  4 A *                  &lt;776&gt; = 2</p>	<p>Stapler / stacker /                  empileur / empilhadeira /                  impilatore / apiladora / hefapparaat</p>
<p><b>Y8</b>                    I max                  4 A *                  &lt;356&gt; = I</p>	<p>Fadenspannungslösen / thread tension release / détenteur de fil /                  soltar tensão da linha / sbloccaggio tendifilo / detensión del hilo /                  verbreken van de draadspanning</p>
<p><b>A10</b>  </p>	<p>Signal Unterfadenwächter / signal bobbin thread sensor</p>
<p><b>[A2]</b></p>	<p>Tastergehäuse an der Nähmaschine / key case at the sewing machine</p>
<p><b>[A3]</b>  </p>	<p>Oberteilerkennung / sewing machine identify unit</p>



- \* Die Summe der Lastströme aller gleichzeitig eingeschalteten Stellglieder (Magnete, Magnetventile) darf den Wert von 4A nicht überschreiten (siehe hierzu Kapitel 2. Technische Daten).
- \* The total of load currents of all servos activated simultaneously (solenoids, solenoid valves) is not allowed to exceed 4 amps (see also section 2. Technical Specifications).
- \* Le total des courants de charge de tous les vérins (aimants, électro-vannes) activés simultanément ne doit pas dépasser 4 A (voir aussi le chapitre 2. "caractéristiques techniques").
- \* A soma das correntes sob carga de todos os actuadores ligados ao mesmo tempo (ímans, solenóides) não pode ultrapassar o valor de 4A (ver também capítulo 2. Dados Técnicos).
- \* La somma delle correnti di carico di tutti gli attuatori inseriti contemporaneamente (magneti, elettrovalvole) non deve essere superiore a 4 A (vedere il capitolo 2. Dati Tecnici).
- \* La suma de las corrientes bajo carga de todos los elementos de todos los componentes de regulación conectados simultáneamente (imanes, válvula magnética) no podrá sobrepasar el valor de 4A (véase también el capítulo 2. de datos técnicos).
- \* De belastingsstroom van alle tegelijkertijd ingeschakelde bedieningsschakels (magneten, magneetventielen) mag in totaal niet meer dan 4 A bedragen (zie hiervoor hoofdstuk 2. Technische gegevens).

# Appendix adaptor cable

## Important Notice!

Your newly purchased **EcoDrive** control system is designed to be connected to a sewing machine/system via connector X5. This connector X5 is a 37 pole sub-d jack as shown in the wiring diagram.

*The connections/wiring of X5 is **not identical nor compatible** with the connections of the same type of jack X5 of the **Ministop control box**, nor with the same type of 37 pole sub-d jack of a **Servo control box**!*

In order to avoid damage to the control box, you may only connect the **EcoDrive** to machines wired according to VDMA Regulations

### EN 60204-31

If you wish to replace a Ministop or Servotop control box with an EcoDrive, you must either use the appropriate adapter cable or rewire your machine!

We offer following adapter cables:

Replacement for Q40MS:	Q40ED with adapter	Art.-No. 55.591
Replacement for P40/51/52/47 MS	P40ED with adapter	Art.-No. 55.592
Replacement for PE40MS	PE40ED with adapter	Art.-No. 55.580
Y-Adapter for synchronizer (position control unit)		Art.-No. 55.570
Extension cable for synchronizer (position control unit) 1,5m		Art.-No. 55.506
Extension cable for speed control unit 1,5m		Art.-No. 55.507
Extension cable for operator panel EcoTop 5m		Art.-No. 55.573
Serial data cable for Q-Prog		Art.-No. 55.577





**Europäische Union**  
Wachstum durch Innovation – EFRE



## PFAFF Industriesysteme und Maschinen AG

Hans-Geiger-Str. 12 - IG Nord  
D-67661 Kaiserslautern

Telefon: +49-6301 3205 - 0  
Telefax: +49-6301 3205 - 1386  
E-mail: [info@pfaff-industrial.com](mailto:info@pfaff-industrial.com)